

Matthews & Fields

LUMBER COMPANY • SINCE 1896

Rochester- (585) 663-0430

Henrietta- (585) 334-5500

Stock Moulding Profiles*

**Profiles subject to change without notice. Profiles shown not necessarily to scale*

Revised 11/15

Table of Contents

	<u>Page</u>
Casing.....	3
Base.....	6
Crown and Cove.....	9
Chair Rail & Wainscot.....	12
Brick and Neck.....	15
Corner Guard.....	17
Lattice & Mull Center Casing.....	18
Panel.....	21
Quarter Round and Shoe.....	22
Stop.....	24
Handrail.....	26
Window Stool and Extension Jambs.....	27
Miscellaneous.....	31

Casing

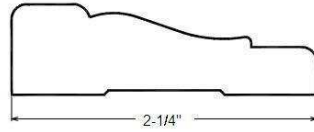

2-1/4" Colonial
Stocked in Clear Pine, FJ Primed Pine, MDF, Red Oak

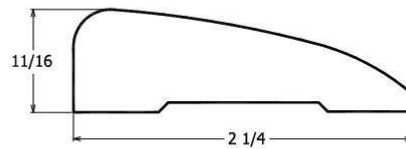

2-1/4" Ranch
Stocked in Clear Pine, FJ Primed Pine, Red Oak

Not Shown: 3-1/4" Five Step Colonial

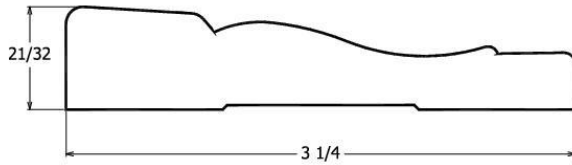

3-1/4" #444 Colonial
Stocked in Red Oak

Note: 3-1/2" version available in MDF, FJ Pine, Clear Pine, & Red Oak

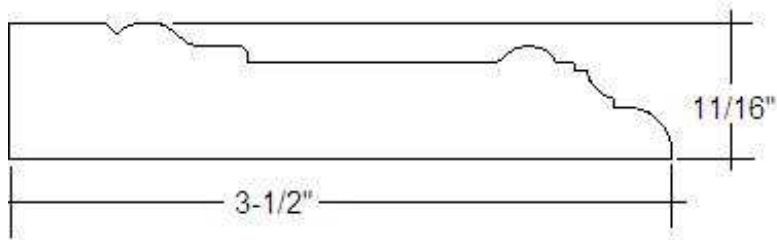

3-1/2" Beaded Contemporary
Stocked in MDF, 16' lengths only

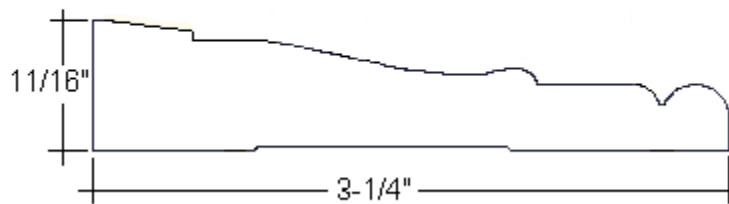

3-1/4" #445 Colonial
Stocked in MDF

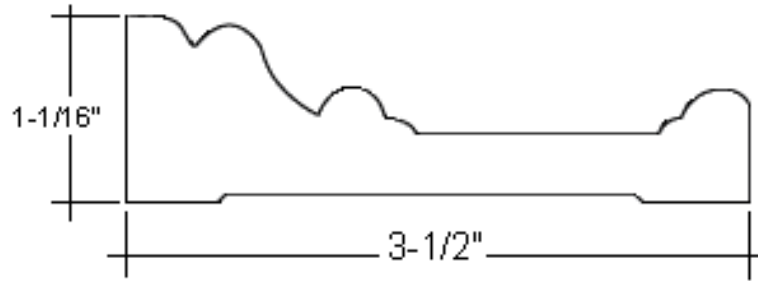

3-1/2" RB3
Stocked in MDF

Base

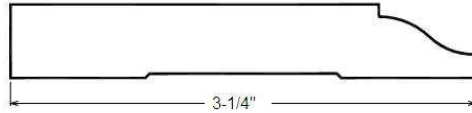

3-1/4" Colonial

Stocked in Clear Pine, FJ Primed Pine, MDF (16' lengths only), Red Oak

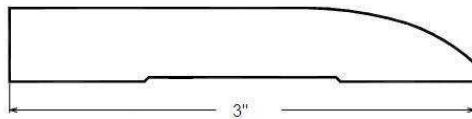

3" Ranch Base

Stocked in Clear Pine, FJ Primed Pine, Red Oak

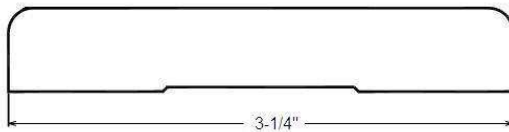

3-1/4" Flat

Stocked in FJ Pine-**TO BE DISCONTINUED WHEN GONE**

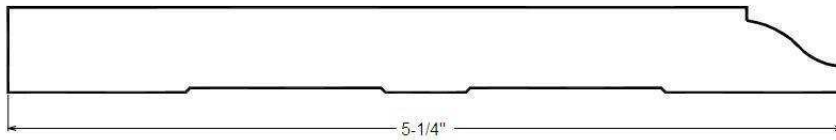

5-1/4" Colonial
Stocked in FJ Primed Pine, MDF (16' lengths only), Red Oak

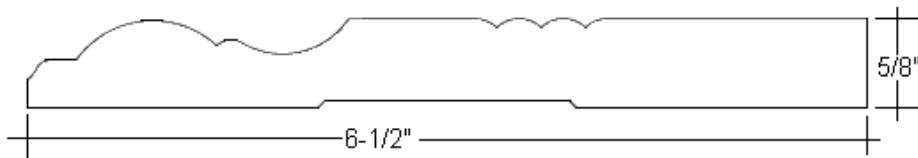

6-1/2" Victorian Beaded
Stocked in MDF, 16' lengths only

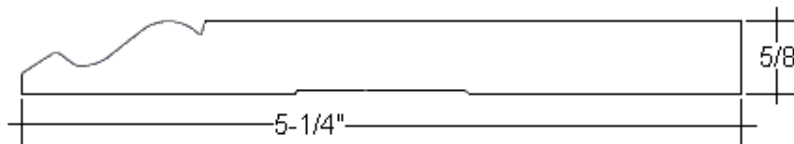

5-1/4" Speed Base
Stocked in MDF, 16' lengths only

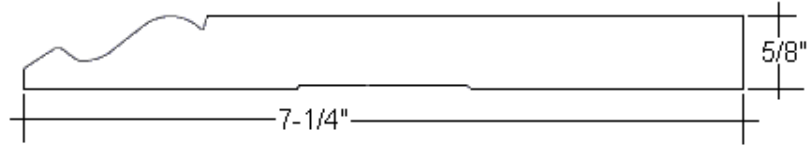

7-1/4" Speed Base
Stocked in MDF, 16' lengths only

Crown and Cove

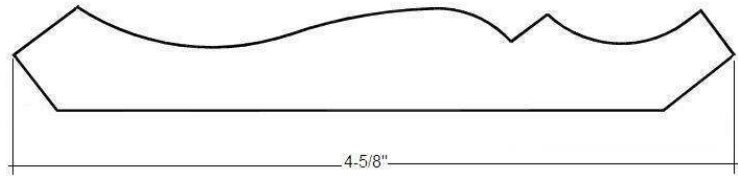

4-5/8" Crown
Stocked in Clear Pine, FJ Pine, MDF (16' lengths only)

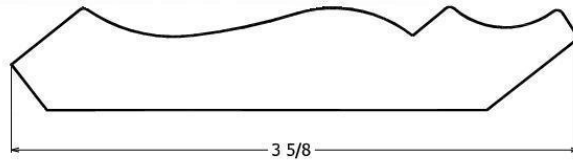

3-5/8" Crown
Stocked in Clear Pine, FJ Primed Pine (16' lengths only), Primed MDF (16' lengths only), Azek PVC (16' lengths only)

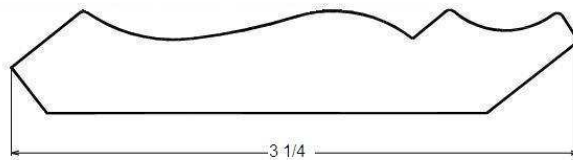

3-1/4" Crown
Stocked in Red Oak

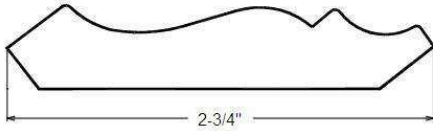

2-3/4" Crown
Stocked in Clear Pine

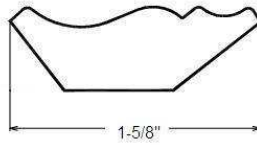

1-5/8" Crown
Stocked in Clear Pine, Red Oak

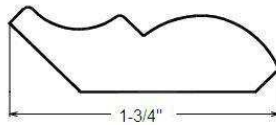

1-3/4" Bed
Stocked in FJ Primed Pine

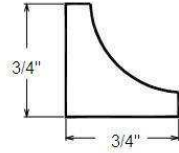

3/4" Cove

Stocked in Clear Pine, Red Oak, Maple, Azek PVC (16' lengths only)

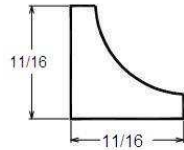

11/16" Cove

Stocked in Clear Pine

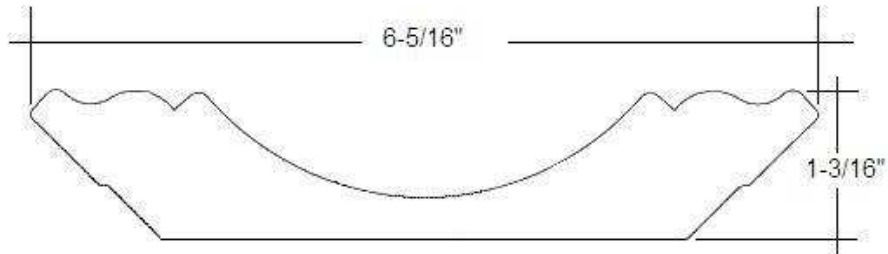

6-5/16" Cove

Special Order MDF, 16' lengths only

Chair Rail & Wainscot

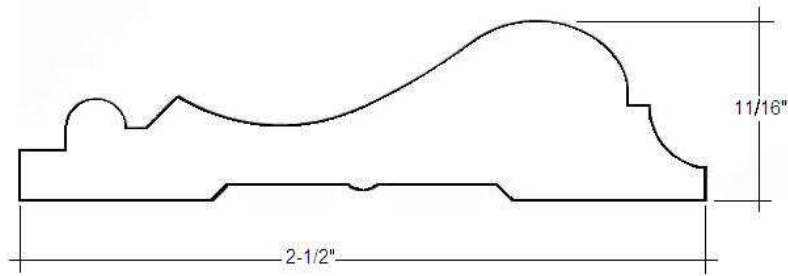

2-1/2" Chair Rail (WM-390)

Stocked in Clear Pine, FJ Primed Pine, MDF (primed, 16' length only)
not shown: WM-297, 3" Chair Rail, MDF primed, (16' length only)

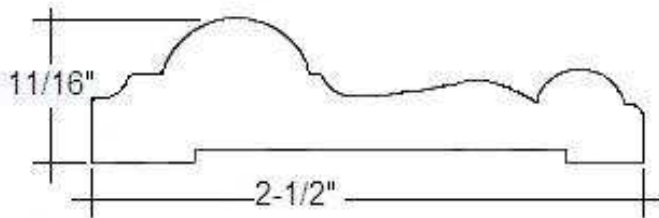

2-1/2" Chair Rail
 Stocked in Red Oak

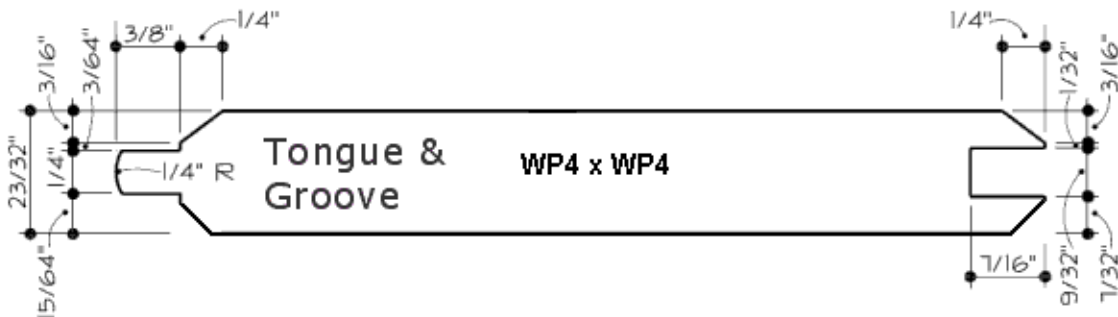

Tongue & Groove

Stocked in 1x6 and 1x8 Eastern Standard Pine, 1x6 D & Better Western Red Cedar, 1x6 #3 & Better Rough Sawn Western Red Cedar

Note: The backside profile may vary, depending on availability from suppliers

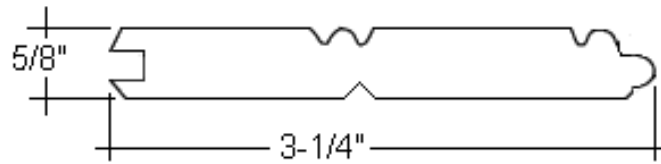

5/8" X 4 Beaded Ceiling
Stocked in Douglas Fir

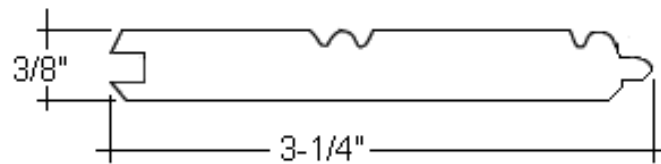

3/8" x 4 Beaded Ceiling
Stocked in Red Oak

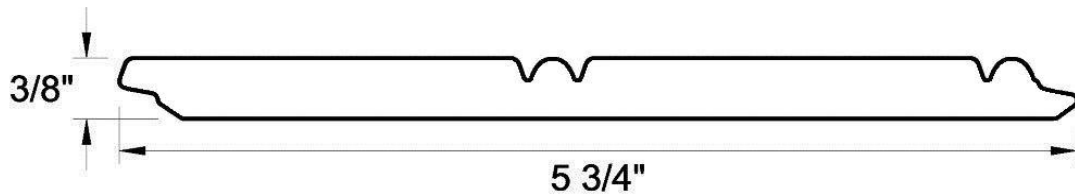

3/8" x 5-3/4" MDF Wainscot, primed, 14' length only

Not Shown: 1x6 T&G Edge and Center Bead Eastern Standard Pine

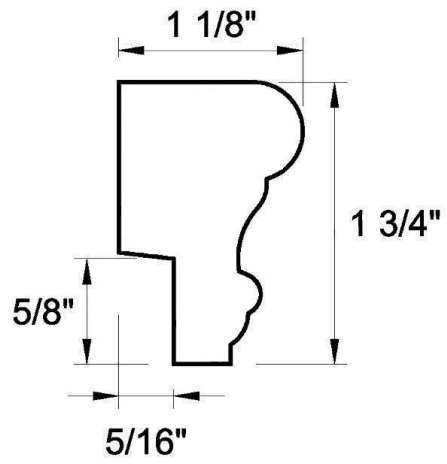

MDF Wainscot Cap Rail, primed, 8' length only

Brick & Neck

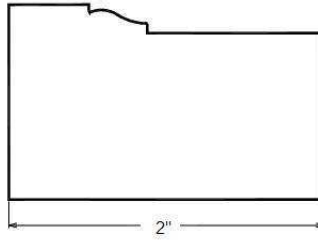

2" Exterior Brick
Stocked in FJ Primed Pine, Azek PVC (17' lengths only)

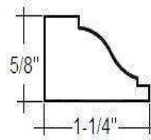

1-1/4" Interior Brick
Stocked in Clear Pine

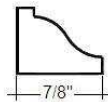

5/8" x 7/8" Neck
Stocked in Clear Pine

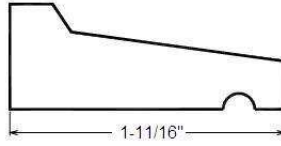

1-3/4" Drip Cap
Stocked in FJ Primed Pine

Corner Guard

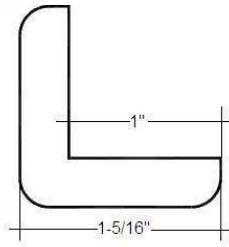

1-5/16" Corner Guard
Stocked in Clear Pine

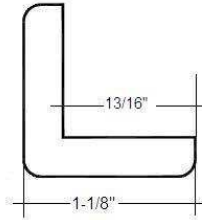

1-1/8" Corner Guard
Stocked in Clear Pine

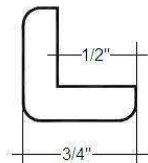

3/4" Corner Guard
Stocked in Clear Pine, Red Oak

Lattice & Mull Center Casing

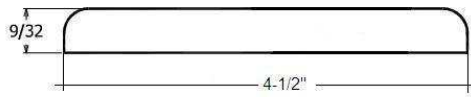

4-1/2" Mull Center Casing
Stocked in Clear Pine

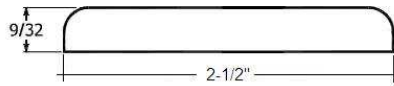

2-1/2" Mull Center Casing
Stocked in Clear Pine

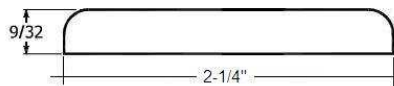

2-1/4" Mull Center Casing
Stocked in Clear Pine

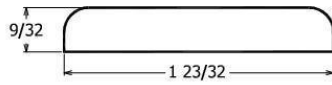

1-3/4" Mull Center Casing
Stocked in Clear Pine

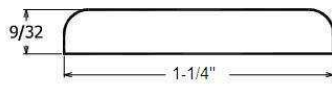

1-1/4" Mull Center Casing
Stocked in Clear Pine

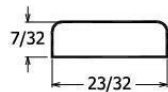

3/4" Screen Bead
Stocked in Clear Pine

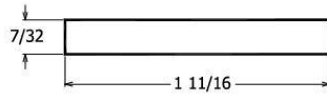

1-3/4" Lattice
Stocked in Clear Pine

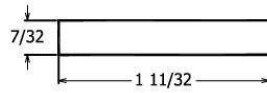

1-3/8" Lattice
Stocked in Clear Pine

Panel

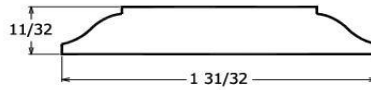

2" Panel
Stocked in Clear Pine

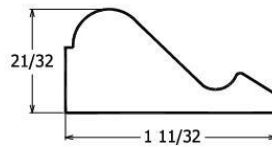

1-3/8" Panel
Stocked in Clear Pine, Red Oak, MDF (primed, 16' length only)

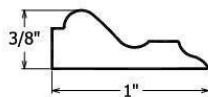

1" Panel
Stocked in Clear Pine

Not Shown: 1-1/8" Azek PVC

Quarter Round & Shoe

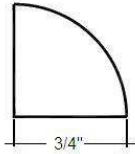

$\frac{3}{4}$ " Quarter Round
Stocked in Clear Pine

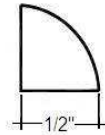

$\frac{1}{2}$ " Quarter Round
Stocked in Clear Pine

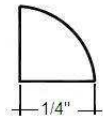

$\frac{1}{4}$ " Quarter Round
Stocked in Clear Pine

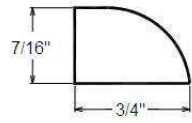

7/16" x 3/4" Shoe

Stocked in Clear Pine, FJ Primed Pine (16' lengths only), Red Oak, Maple

Stop

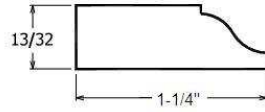

1-1/4" Colonial Stop
Stocked in FJ Primed Pine

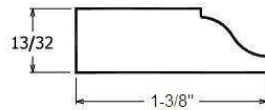

1-3/8" Colonial Stop
Stocked in Clear Pine, Red Oak

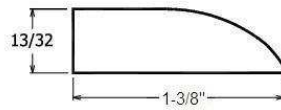

1-3/8" Ranch Stop
Stocked in Clear Pine, Red Oak

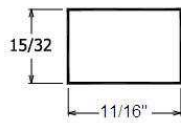

$1/2$ " x $3/4$ " Check Stop
Stocked in Clear Pine

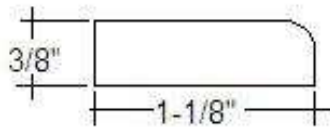

$1-1/8$ " R1E Stop
Stocked in Clear Pine, 7' lengths only

Handrail

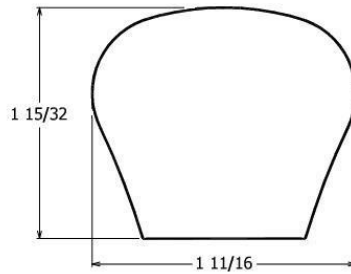

Bread loaf Handrail
Stocked in Clear Pine, Red Oak

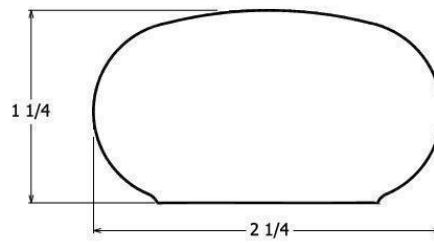

Oval Handrail
Stocked in Clear Pine

Window Stool & Extension Jambs

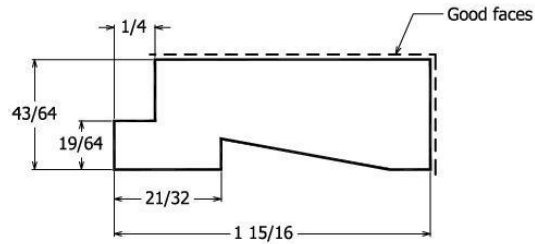

Andersen 1-11/16" Casement/Awning Extension Jamb
Stocked in Clear Pine

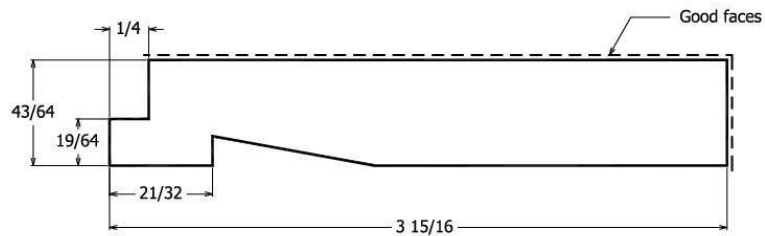

Andersen 4" Casement/Awning Extension Jamb
Stocked in Clear Pine

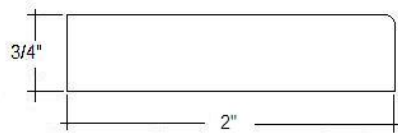

2" Narrowline Extension jambs
Stocked in FJ Primed Pine

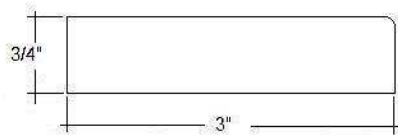

3" Narrowline Extension jambs
Stocked in FJ Primed Pine

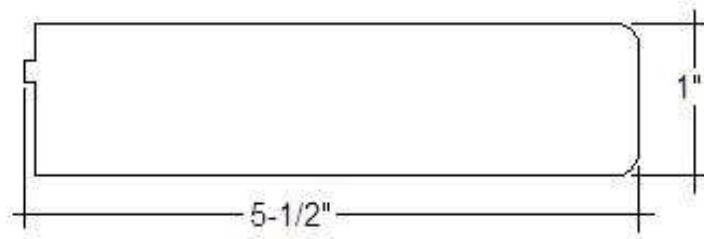

5/4 x 5-1/2" Andersen Casement Stool
Made to Order in all Species

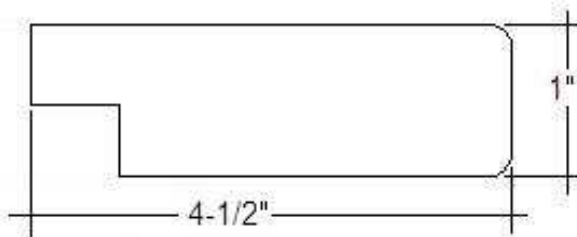

5/4 x 4-1/2" DH Stool, Rabbeted
Made to Order in all species

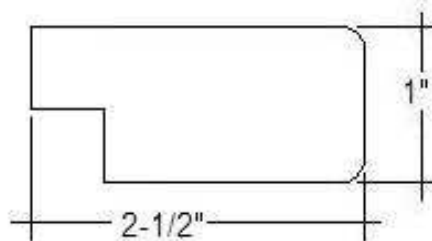

5/4 x 2-1/2" DH Stool, Rabbeted
Stocked in FJ Primed Pine
Made to Order in all other species

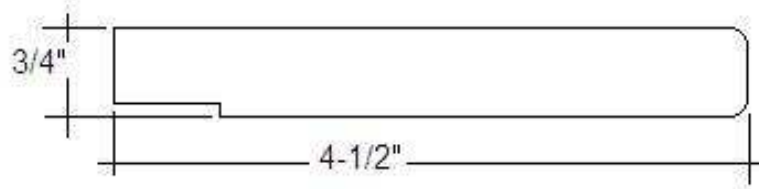

$\frac{3}{4}$ " x 4-1/2" Stool
Made to Order in all species

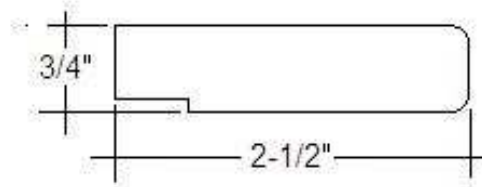

$\frac{3}{4}$ " x 2-1/2" Stool
Made to Order in all species

Miscellaneous

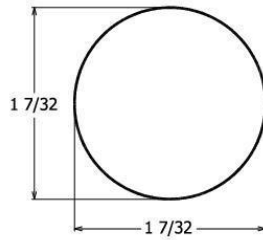

1-5/16" Closet Rod
Stocked in Clear Pine

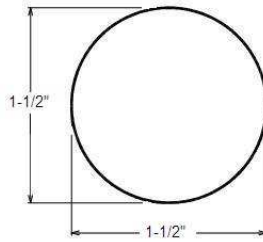

1-1/2" x 10' Dowel
Stocked in White Hard Maple